

Installation and User's Guide



EN

DE

FR

NL

IMPORTANT SAFETY INFORMATION:

Read this manual first before attempting to install or use this electric fire. Always comply with the warnings and safety instructions contained in this manual and presented on the appliance to prevent personal injury or property damage.

The product complies with the required Product Safety, Electromagnetic Compatibility and Environmental Standards. This product is fully compliant with LVD, EMC, RoHs and EcoDesign Directives.



EN: This product is only suitable for well insulated rooms or occasional use. DE: Dieses Produkt ist nur für gut isolierte Bereiche oder gelegentliche Verwendung geeignet. FR: Ce produit convient uniquement à des endroits bien isolés ou pour un usage occasionnel. IT: Questo prodotto è adatto solo per spazi ben isolati o per uso occasionale. ES: Este producto sólo es adecuado para espacios bien aislados o un uso ocasional. NL: Dit product is uitsluitend geschikt voor goed geïsoleerde ruimten of voor sporadisch gebruik. PL: Produkt ten jest odpowiedni wyłącznie do dobrze odizolowanych miejsc lub do okazjonalnego użyciu. NO: Dette produktet egner seg kun for godt isolerte rom eller sporadisk bruk. RO: Acest produs este adecvat exclusiv spațiilor bine ventilate sau utilizării ocazionale. CZ: Tento výrobek je vhodný pouze do dobře izolovaných prostor nebo k příležitostnému použití. DK: Dette produkt er kun egnet til velisolerede rum eller lejlighedsvis brug. PT: Este produto somente é adequado para espaços bem isolados ou uso ocasional. SE: Denna produkt är endast avsedd för välisolerade utrymmen eller tillfällig användning. FI: Tämä tuote soveltuu ainoastaan hyvin eristettyihin tiloihin tai satunnaiseen käyttöön. SK: Tento výrobok je vhodný len pre dobre izolované priestory alebo na občasné použitie. SI: Ta izdelek je primeren le za dobro izolirane prostore ali za obasno uporabo. HR: Ovaj proizvod je pogodan samo za dobro izolirane prostore ili povremenu upotrebu. HU: Ez a termék csak jól szigetelt terekhez vagy eseti használatra alkalmas.

Table of Contents

Welcome	3
 IMPORTANT INSTRUCTIONS	4
Technical Specifications	6
Electrical Rating	6
Technical Information	6
Product Dimensions	6
Package Contents	7
Installation	9
Placement	9
Preparing the Firebox for Installation	10
Installation Instructions	11
Electrical Installation	14
Heater Hardware Disconnect	15
Mirrored Glass Installation	16
Media Arrangement	16
Side Glass Installation	17
Front Glass Installation	17
Operation	18
General Operation	18
Hidden Touch Controls	18
Remote Operation	18
App	18
Resetting the Temperature Cutoff Switch	18
Maintenance	21
Remote Control Battery Replacement	21
Cleaning	21
Servicing	21
Troubleshooting	22

Welcome

MODEL NUMBER AND SERIAL NUMBER

Please record your model and serial numbers for future reference.

Model _____

Serial Number _____

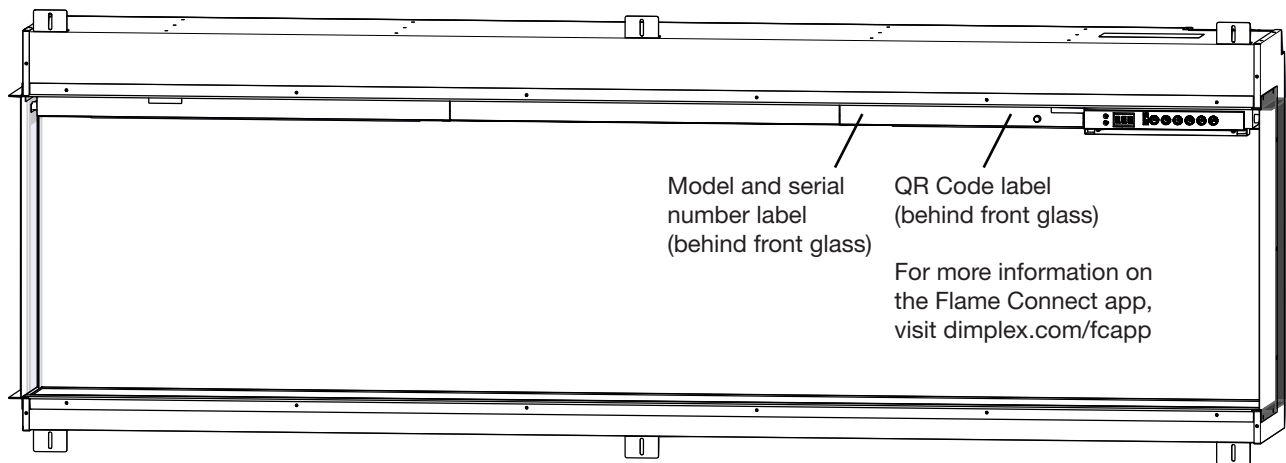

SAVE THESE INSTRUCTIONS

IMPORTANT INSTRUCTIONS

CAUTION: FAILURE TO FOLLOW THESE INSTRUCTIONS MAY CAUSE INJURY AND/OR DAMAGE AND MAY INVALIDATE YOUR GUARANTEE

Important Safety Advice

When using electrical appliances, basic precautions should always be followed to reduce the risk of fire, electrical shock and injury to persons, including the following:

- If the appliance is damaged, check with the supplier before installation and operation.
- Do not use outdoors.
- Do not use in the immediate surroundings of a bath, shower or swimming pool.
- Do not locate the appliance immediately below a fixed socket outlet or connection box.

Warning: This heater must not be used for anything other than normal domestic household purposes in the country where it was purchased from a recognised commercial retailer.

Do not use this heater if it has been dropped

Do not use if there are visible signs of damage to the heater.

Use this heater on a horizontal and stable surface, or fix it to the wall, as applicable.

Children of less than 3 years should be kept away unless continuously supervised. Children aged from 3 years and less than 8 years shall only switch on/off the appliance provided that it has been placed or installed in its intended normal operating position and they have been given supervision or instruction concerning use of the appliance in a safe way and understanding the hazards involved. Children aged from 3 years and less than 8 years shall not plug in, regulate and clean the appliance or perform user maintenance.

CAUTION: Some parts of this product can be very hot and cause burns. Particular attention has to be given where children and vulnerable people are present.

This appliance can be used by children aged from 8 years and above and persons with reduced physical, sensory or mental capabilities or lack of experience and knowledge if they have been given supervision or instruction concerning use of the appliance in a safe way and understand the hazards involved. Children shall not play with the appliance. Cleaning and user maintenance shall not be made by Children without supervision.

Warning: Do not use this heater in small rooms when they are occupied by persons not capable of leaving the room on their own, unless constant supervision is provided.

Warning: In order to avoid overheating, do not cover the appliance. Do not place material or garments on the appliance, or obstruct the air circulation around the appliance, for instance by curtains or furniture, as this could cause overheating and a fire risk.

The appliance carries a "Do Not Cover" warning. 

Warning: To reduce the risk of fire, keep textiles, curtains, or any other flammable material a minimum distance of 1m from the air outlet.

Warning: In order to avoid a hazard due to inadvertent resetting of the thermal cut-out, this appliance must not be supplied through an external switching device, such as a timer, or connected to a circuit that is regularly switched on and off by the utility.

IMPORTANT INSTRUCTIONS

WARNING: KEEP BATTERIES OUT OF REACH OF CHILDREN

- Swallowing may lead to serious injury in as little as 2 hours or death, due to chemical burns and potential perforation of the oesophagus.
- If you think batteries might have been swallowed or placed inside any part of the body seek immediate medical attention
- Examine devices and make sure the battery compartment is correctly secured, e.g. that the screw or other mechanical fastener is tightened. Do not use if the compartment is not secure.
- Dispose of used button batteries immediately and safely. Flat batteries can still be dangerous.

CAUTION: No obvious symptoms

Unfortunately, it is not obvious when a button or coin battery is stuck in a child's oesophagus (food pipe).



There are no specific symptoms associated with this. The child might:

- cough, gag or drool a lot;
- appear to have a stomach upset or a virus;
- be sick;
- point to their throat or stomach;
- have a pain in their abdomen, chest or throat;
- be tired or lethargic;
- be quieter or more clingy than usual or otherwise "not themselves";
- lose their appetite or have a reduced appetite; and
- not want to eat solid food/be unable to eat solid food.

These sorts of symptoms vary or fluctuate, with the pain increasing and then subsiding.

A specific symptom to button and coin battery ingestion is vomiting fresh (bright red) blood. If the child does this seek immediate medical help.

- The lack of clear symptoms is why it is important to be vigilant with "flat" or spare button or coin batteries in the home and the products that contain them.

<p> WARNING</p> <p>KEEP OUT OF REACH OF CHILDREN</p> <p>Swallowing can lead to chemical burns, perforation of soft tissue, and death. Severe burns can occur within 2 hours of ingestion. Seek medical attention immediately.</p>	
--	---



Technical Specifications

Electrical Requirements

⚠ WARNING: Construction and wiring must comply with local building codes and other applicable regulations to reduce the risk of fire, electric shock and injury to persons.

⚠ WARNING: To reduce the risk of fire, electric shock or injury to persons, always use a licensed electrician.

! NOTE: A dedicated, properly fused 13 Amp circuit is required, rated for the appropriate voltage (230-240V). An isolation switch should also be incorporated in cases where the product plug is inaccessible after installation.

Technical Information

Rating: 230-240V~50Hz

Heat Output		230V		240V	
Nominal Heat Output	P_{Nom}	1.8	-	1.9	kW
Minimum Heat Output	P_{min}	0.9	-	0.9	kW
Maximum Continuous Heat Output	$P_{max,c}$	1.8	-	1.9	kW

Auxiliary Electricity Consumption

In Standby Mode	el_{SB}	0.5	-	0.5	W
-----------------	-----------	-----	---	-----	---



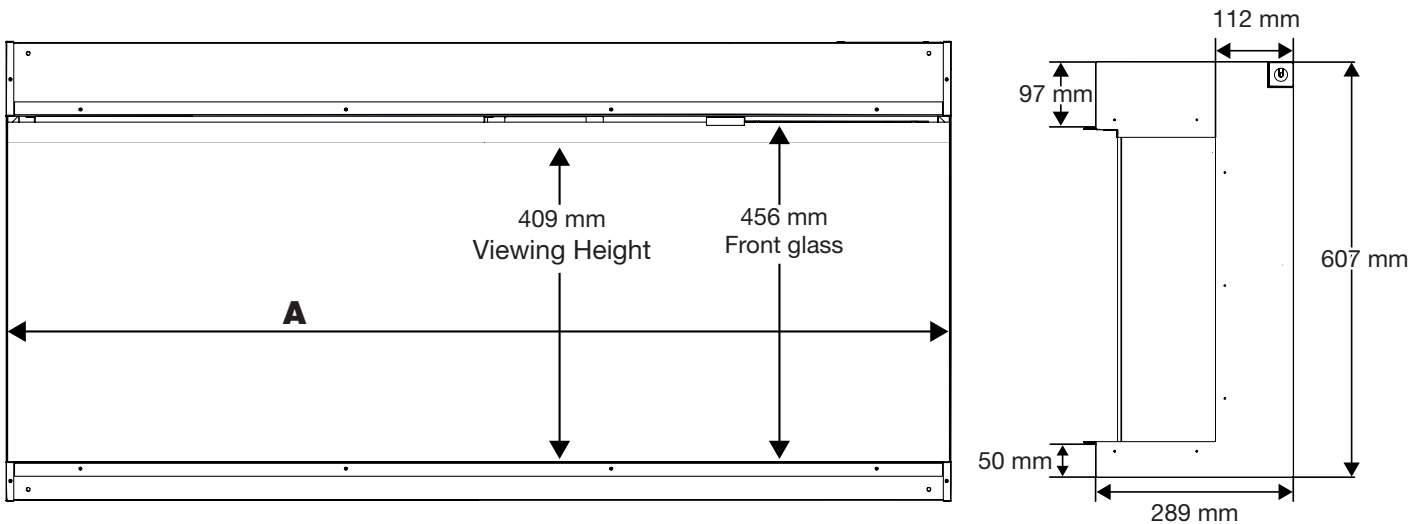

with electronic room temperature control.

Product Dimensions



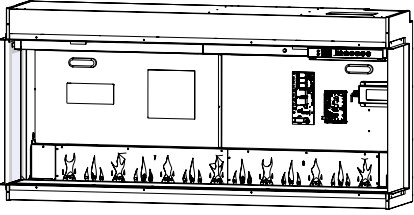
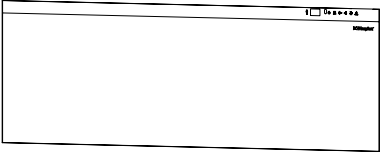
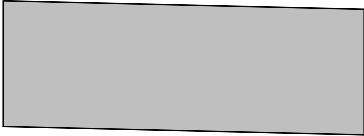

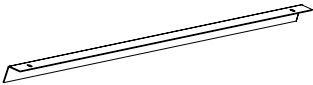
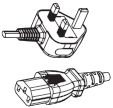
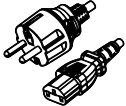

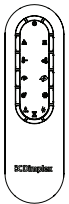

Model	A
BXLF1200	1246 mm
BXLF1500	1565 mm
BXLF1800	1883 mm

Package Contents

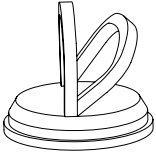
Image	Description	Quantity		
		BXLF1200	BXLF1500	BXLF1800
	Firebox	1	1	1
	Front Glass	1	1	1
	Mirrored Glass	1	1	1
	Side Glass	2	2	2
	Closed Side Trim	2	2	2
	Mirrored Glass Bracket (lengths may vary)	1	2	2
	UK Cord Set	1	1	1
	EU Cord Set	1	1	1
	Logs	6	8	9
	Tumbled Glass Media	4 kg	5 kg	6 kg

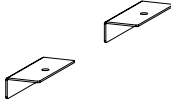
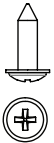
Package Contents

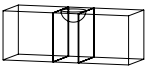
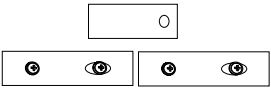
Image	Description	BXL1200	BXL1500	BXL1800
	Remote Control	1	1	1
	User's and Installation Guide	1	1	1
 <p data-bbox="113 965 523 1081"><i>Do not dispose of the suction cup after installation. Keep it in a secure location as it will be helpful for maintenance and service of the unit.</i></p>	Suction Cup	1	1	1
Hardware Kit				
	Mounting Brackets	4	4	6
	Front Glass Brackets	1	2	2
	25.4 mm Wood Screws	4	4	6
	Black Screws	11	14	16
	Bubble Level	1	1	1
	Linking Kit (2 brackets, 1 clip bracket & 4 screws)	1	1	1

Installation

Placement

! **NOTE:** It is recommended that the bottom of the unit be mounted between 13 cm and 1 m from the ground to maintain an optimized viewing angle of the flame.

⚠ **WARNING:** The top of the fireplace must be installed a minimum of 61 cm from the ceiling. The fireplace must be installed a minimum of 13 cm from the ground.

Wi-Fi

For installations where the use of the Flame Connect app is desired, ensure the fireplace is located within range of a Wi-Fi network.

Installation Recommendations for Overhanging Objects

For overhanging temperature-sensitive objects, such as a television, a mantel, or artwork, always follow the recommendations provided by its manufacturer for installation over a heater.

! **NOTE:** Using normal heat mode, surfaces 7" (177.8 mm) above the fireplace will not exceed 40° C, as long as installation procedures are followed and heater inlet and outlet are not obstructed.

Installation

Preparing the Firebox for Installation

! **NOTE:** For multi-unit installation, refer to instructions provided with the linking kit.

1. Remove packing support brackets by removing the screws on each bracket. (Figure 1) These brackets and screws can be discarded.
2. Install the desired side trim option on each side of the firebox. Install the side panel using 7 black screws.
 - For open sides, select the open side trim. The open side trim comes preinstalled on the fireplace. (Figure 2)
 - For closed sides, install the closed side trim. (Figure 3) Do not install the side glass panels in this configuration.
 - For multi-unit installations, remove side panels on adjoining sides by removing the 9 screws. (Figure 4) Do not install any trim or side glass on adjoining sides.
3. Install the power cord, following the instructions in the *Electrical Installation* section (p. 14).
4. If a permanently heat-disabled installation is desired, follow the instructions to disable the heater in the *Permanent Heat Disable* section (p. 15).
5. Carefully lay the firebox on its back and install the mounting brackets to the top and bottom of the firebox with the black screws provided. (Figure 5)

! **NOTE:** There are 4 mounting brackets for BXLF1200 and BXLF1500 units (Figure 6), and 6 mounting brackets for BXLF1800 units. (Figure 7)

! **NOTE:** The mounting brackets are equipped with slots to allow small adjustments to fit the framing. Ensure all the brackets are aligned.

Figure 1

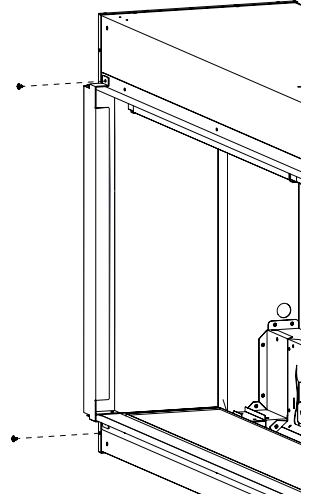

Figure 2

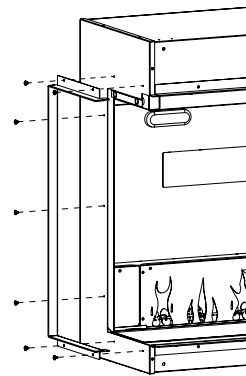

Figure 3

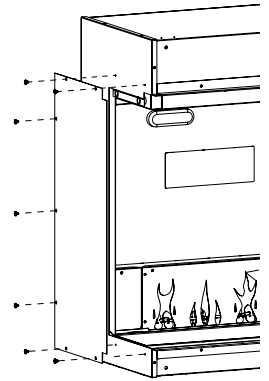

Figure 5

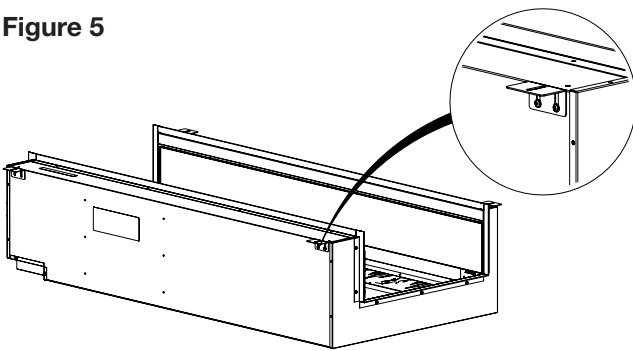

Figure 6

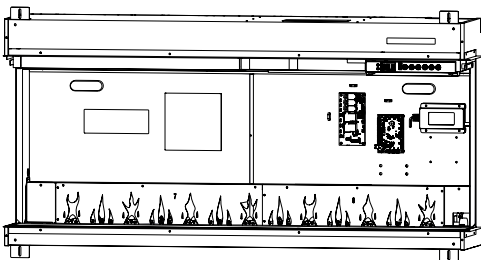

Figure 7

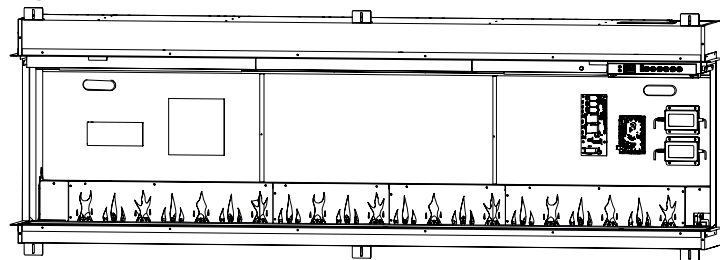
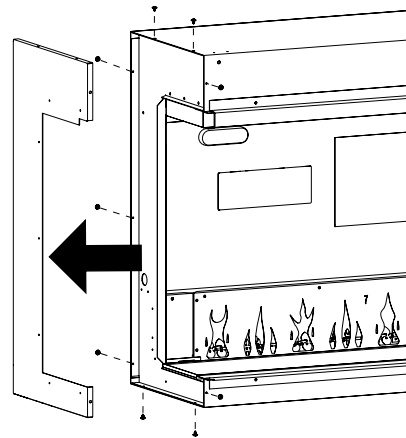

Figure 4



Installation

Installation Instructions

! **NOTE:** Two people are required for installation.

1. Prepare a wall with a framed opening, following the dimensions in the table below. The dimensions are the same for front, corner, and bay installations.

! **NOTE:** These framing dimensions are based on installation with 13 mm drywall.

Framing Dimensions

Model	Width	Height	Depth (minimum)
	A	B	C
BXLF1200	1257 mm	616 mm	295 mm
BXLF1500	1581 mm		
BXLF1800	1895 mm		
Custom length for linked	Add widths of units used		

Figure 8
Bay Installation

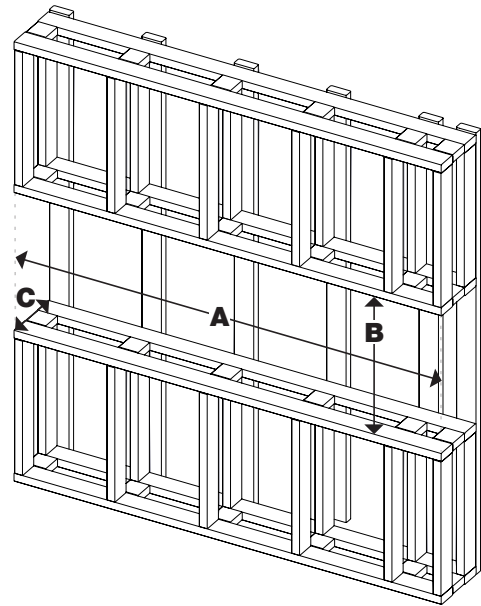

⚠ **CAUTION:** This fireplace is **NOT** load-bearing. Ensure the opening for the fireplace is framed in such a way that the weight of the building materials will not create pressure on the top of the fireplace.

! **NOTE:** Wiring is located at the top right back corner of the firebox. Plan the framing to allow routing the power cord to this location.

Figure 9
Left/Right Corner Installation

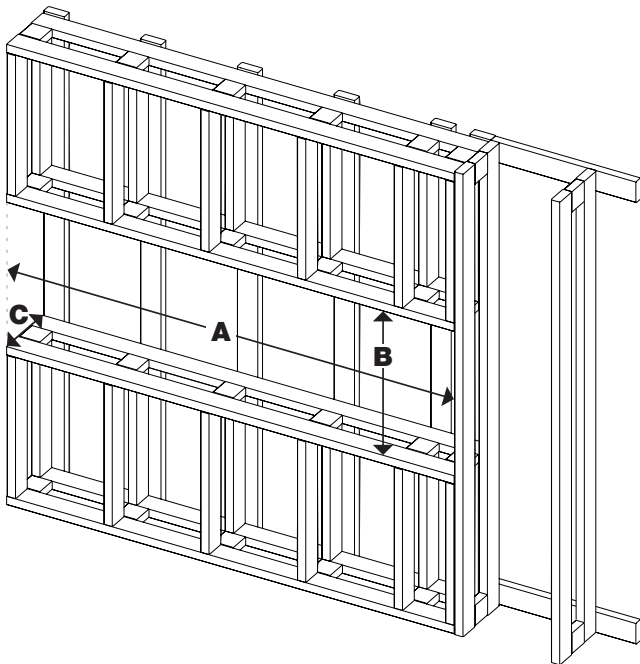
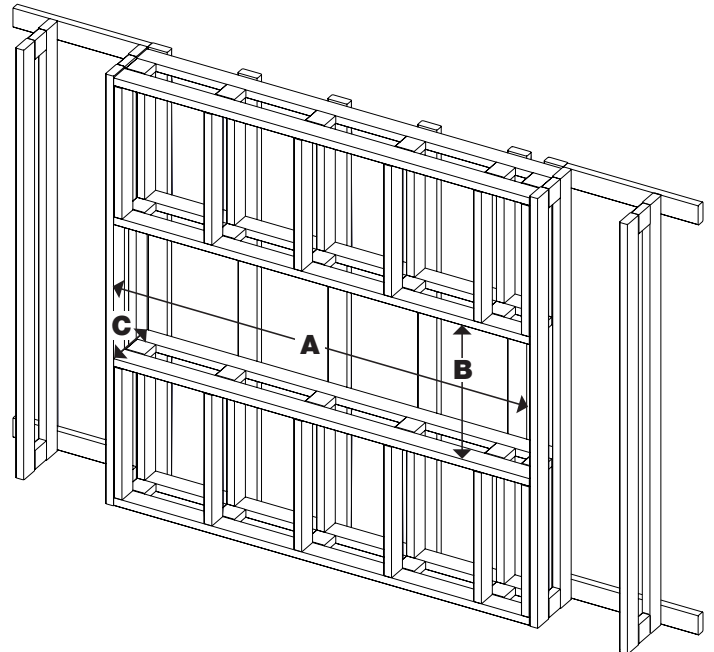

Figure 10
Front Installation



Installation

- Lift the firebox into the opening in the frame using the handles on the back of the fireplace.
- ! NOTE:** Ensure the instructions for *Preparing the Firebox for Installation* (p. 10) have been completed prior to installation.
- Plug in the power cord coming from the fireplace.
- Level the firebox. A bubble level is included in the hardware kit provided.
- For multi-unit installations, install the joining brackets between adjoining fireplaces. (**Figure 11**)
- Secure the mounting brackets to the framing on both the top and bottom using the provided wood screws. (**Figure 12**) The mounting brackets will prevent the firebox from shifting in the framing.
- Install finishing material up to the trim. (**Figures 13 and 14**)
- ! CAUTION:** Do not drill into firebox housing.
- Finish the installation using the finishing materials of your choice.
- Complete the installation using the instructions in the following sections: *Mirrored Glass Installation* (p. 16), *Arranging Media* (p. 16), *Front Glass Installation* (p. 17), and *Side Glass Installation* (p. 18).

Figure 11

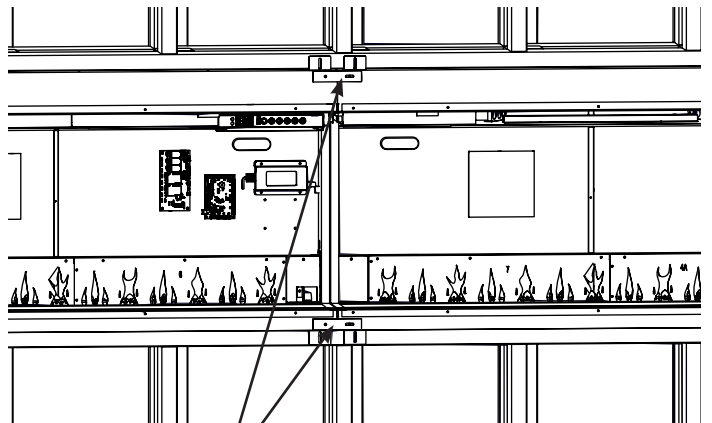

Adjoining brackets for multi-unit installations

Figure 12

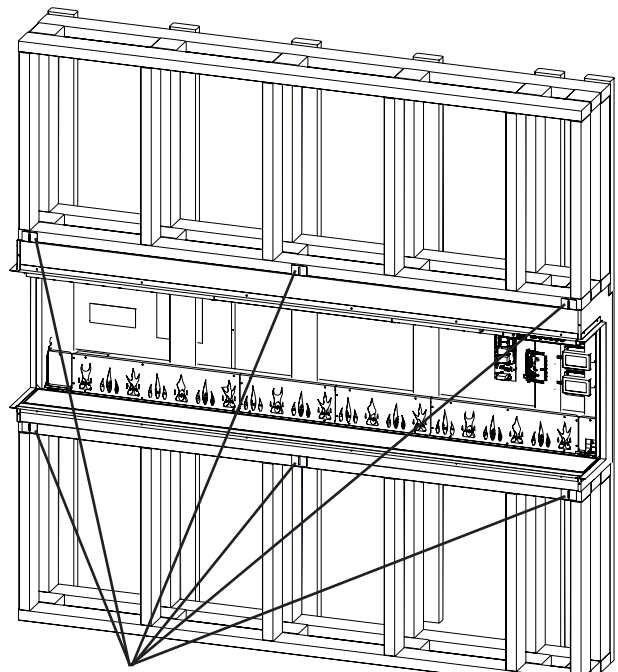

Mounting brackets
(center brackets not present on BXLF1200 and BXLF1500 units)

Installation

Figure 13

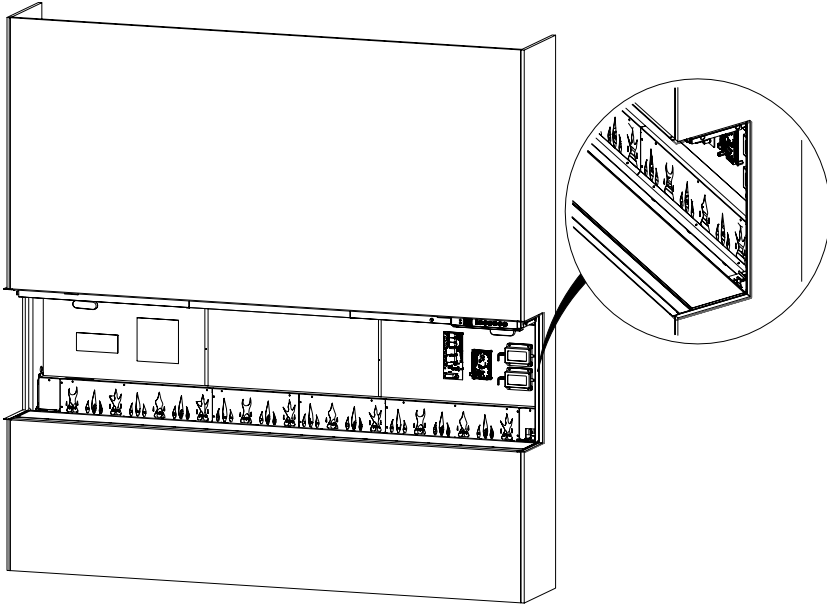
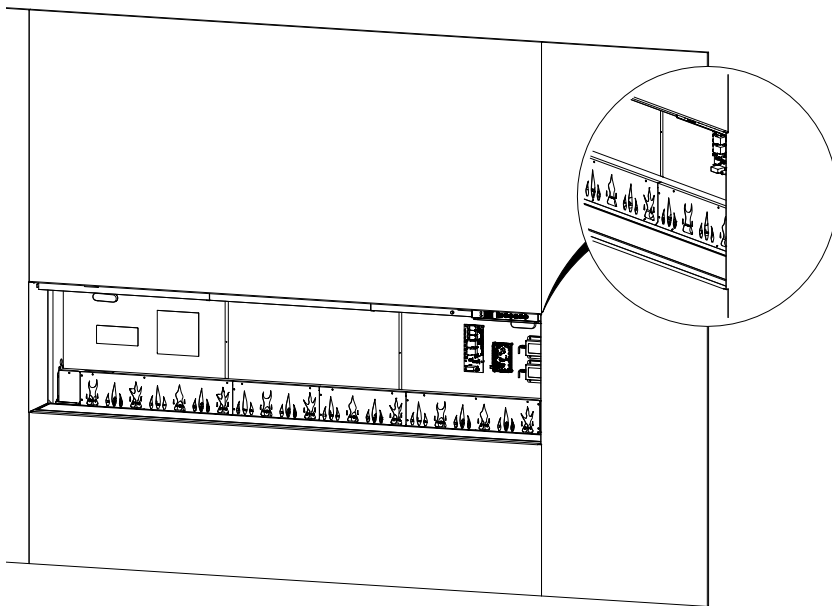

Figure 14



Installation

Electrical Installation

⚠ WARNING:

The installation of the electric fireplace must comply with the applicable Local and/or National Electrical Codes and utility requirements.

Use the appropriate cord to meet local and national electrical codes for rated power consumption.

⚠ CAUTION: A dedicated, properly fused 13 Amp circuit is required, rated for the appropriate voltage (230-240V). An isolation switch should also be incorporated in cases where the product plug is inaccessible after installation.

Power Cord Installation

1. Select the suitable cord set (the EU or UK option). (Figure 15)
2. Install the power cord by plugging it into the corded receptacle on the fireplace. (Figure 16)

⚠ WARNING: This heater is not intended for use with an extension cord. Plug the cord directly into an appropriate grounded receptacle.

Figure 15

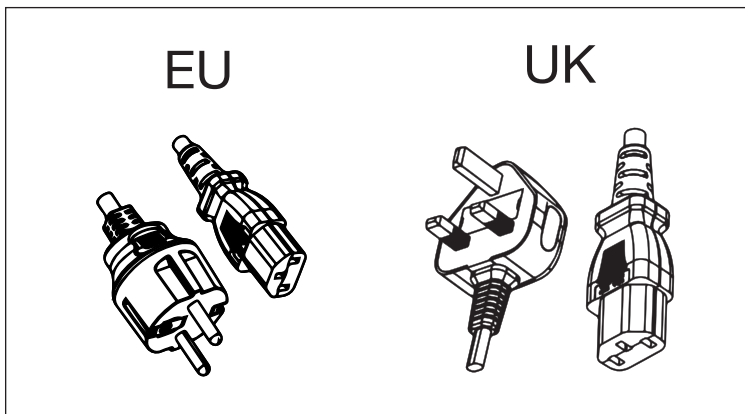
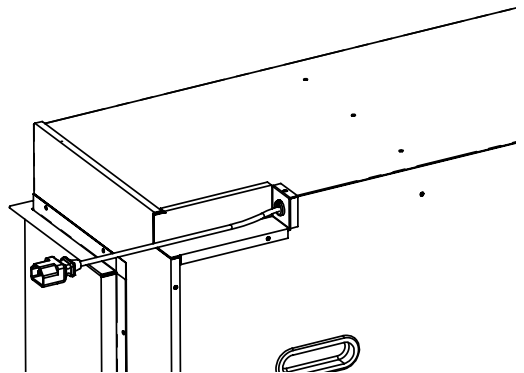

Figure 16



Heater Hardware Disconnect

The fireplace heater can be permanently disabled by removing the electronic jumper on the control board.

! NOTE: Heater hardware disconnect will permanently disable the heater and fan. Follow these instructions only when an installation without heat is required. Temporary disabling of the heater can be achieved through the hidden touch controls. See “Heat Disable” in *Operation* section (page 19) for instructions.

To disconnect the heater and fan permanently:

1. Locate the control board. The heater hardware disconnect jumper location is labeled “HEAT”. (Figure 17)
2. Pull out the heater hardware disconnect jumper.

Figure 17

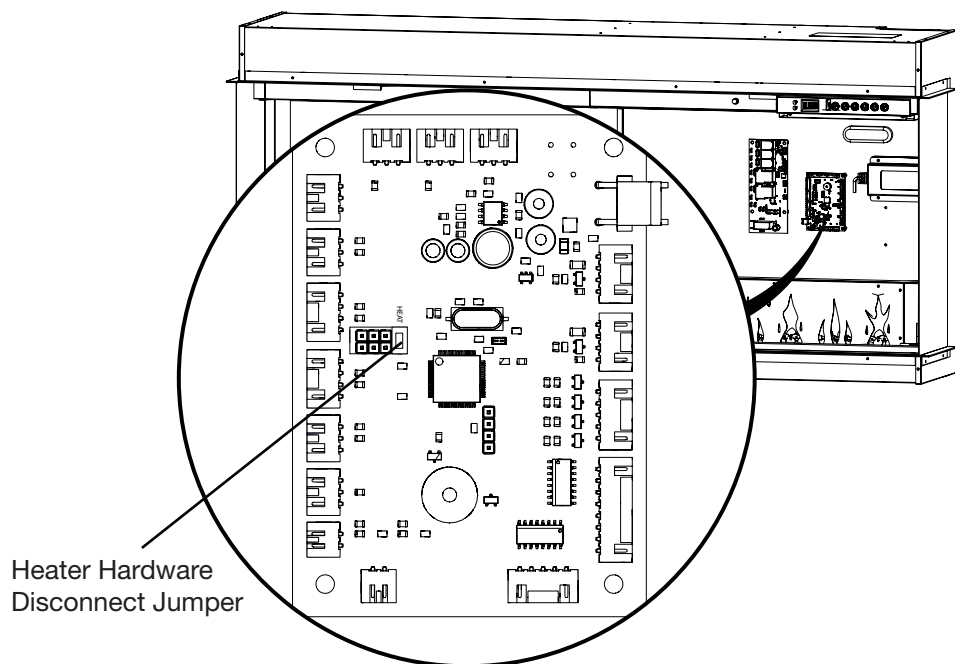

Installation

Mirrored Glass Installation

1. Attach the provided suction cup to the reflective side of the mirrored glass. Ensure the suction cup is securely attached.
2. Using the suction cup to assist, lift the mirrored glass and place it into the bottom slot at an angle.
3. Tilt the mirrored glass into a vertical position. (Figure 17)
4. Align the holes on the inside of the unit with the holes on the bracket and install the mirrored glass brackets using the provided black screws. (Figure 18)

! **NOTE:** Use a flashlight to locate the screw holes in the fireplace.

⚠ **CAUTION:** Ensure the mirrored glass does not fall forward while the mirrored glass mounting brackets are being installed.

5. Remove the suction cup and clean any fingerprints or debris off the glass with a non-abrasive glass cleaner.

! **NOTE:** Do not dispose of the suction cup! Keep it in a secure location, as it may be needed for maintenance and service on this fireplace.

Figure 18

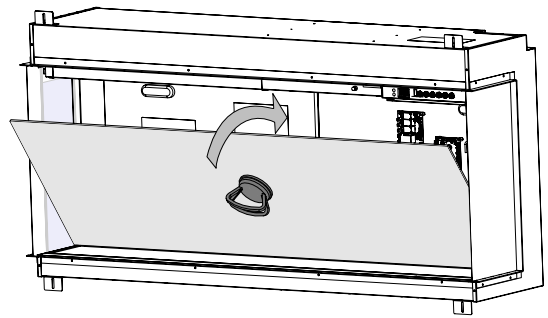
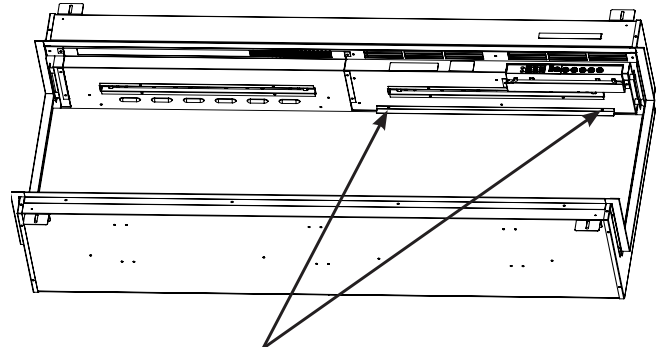

Figure 19



Mirrored Glass Bracket Screws

! **NOTE:** BXL1500 and BXL1800 have two brackets. One bracket is on the inner top right side of the unit and the other is on the left.

Media Arrangement

For best results when using the supplied media, arrange as follows:

! **NOTE:** Remove the plastic film from the media bed before adding the media.

1. Mix the tumbled glass media pieces.
2. Evenly disperse the tumbled glass media to entirely cover the media bed.

! **NOTE:** For a more realistic appearance, arrange the black and grey tumbled glass media around the front and sides of the media bed.

3. Place the log pieces on top of the tumbled glass media.

It is possible to use custom media ornaments to decorate your firebox. The custom media must fit easily without scratching the glass or bowing the media bed, and must not be composed of sand or liquid, which could interfere with the safety of the firebox.

Figure 20

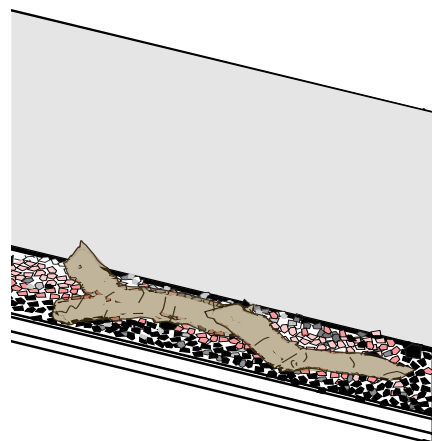

Installation

Side Glass Installation

1. Ensure the matte side of the upper black trimming is oriented toward the inside.
2. Insert the top of the glass panel into the upper slot.
3. Carefully tilt it toward the inside until it is in the vertical position. Once in place, it will drop into the correct position. (Figure 20)
4. Repeat on the other side for bay installations.

Front Glass Installation

! NOTE: Wait to power on the unit after the front glass is installed. If the power is already connected prior to the front glass installation, cycle the power on and off to engage the hidden touch controls.

1. Ensure there are no debris or finger prints on the mirrored glass, inner sides of the side glass, or on the inner side of the front glass before you begin.
2. Attach the provided suction cup to the outer side of the front glass. Ensure the suction cup is securely attached.
3. Using the suction cup to assist, lift the glass and place it into the bottom slot at an angle.
4. Tilt the glass into a vertical position. (Figure 21)
5. Secure using the provided front glass brackets and black screws provided. (Figure 22)

! NOTE: There is one front glass bracket for the BXLF1200, and two front glass brackets for the BXLF1500, and BXLF1800 units.

⚠ CAUTION: Ensure the front glass does not fall forward while the glass mounting brackets are being installed.

6. Remove the suction cup and clean any fingerprints or debris off the glass with a nonabrasive glass cleaner.

! NOTE: Do not dispose of the suction cup! Keep it in a secure location, as it may be needed for maintenance and service on this fireplace.

Figure 21

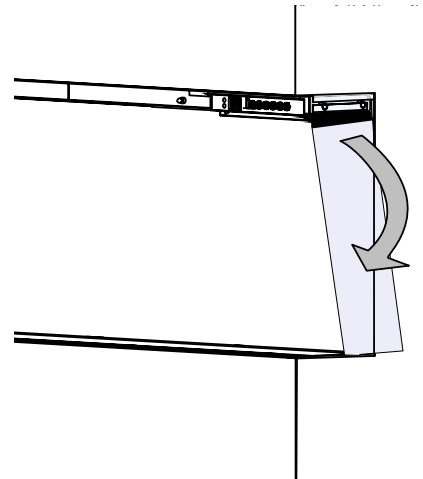

Figure 22

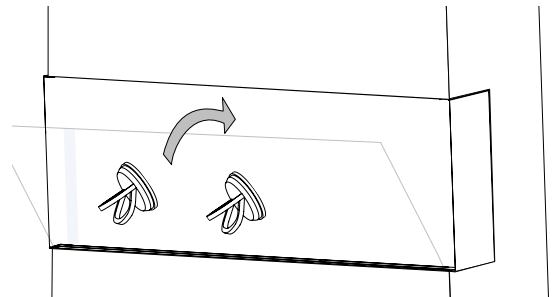
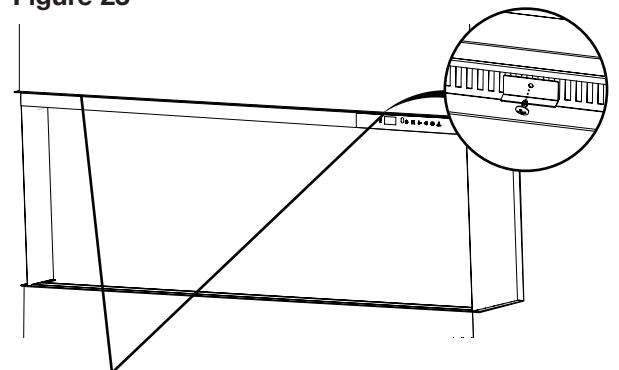

Figure 23



Front Glass Brackets

Operation

General Operation

⚠ WARNING: This electric firebox must be properly installed before it is used.

This firebox operates with ComfortSaver™ technology, which automatically adjusts the fan speed and heater wattage to safely and precisely match the requirements of the room based on the thermostat setting. The heater operates such that once the room reaches the set point, the fan and heater will continuously run at a low level, to maintain the desired room temperature. If the temperature in the room rises significantly, the heater will turn off and periodically turn back on to circulate the air around the unit, until the room temperature drops and requires the heater to be on again.

! NOTE: The element retains heat after shutdown. When the heat is turned off, there is a two-minute cool down period before the fan shuts off completely.

! NOTE: The fireplace will retain the previously used settings after a power interruption.

Hidden Touch Controls

The hidden touch controls are located on the upper right of the fireplace. (Figure 23)

Remote Operation

The fireplace is supplied with a multifunction IR remote control. (Figure 24)

! NOTE: To operate correctly, the remote control must be pointed toward the front of the unit.

App

The fireplace is capable of being controlled using the Flame Connect app for mobile devices. For up-to-date information about the app, please visit www.dimplex.com/fcapp

Resetting the Temperature Cutoff Switch

Should the heater overheat, a manual limit cut-out will turn the unit off and it will not come back on without being reset. It can be reset by turning the unit off at the main disconnect panel and waiting 30 minutes before turning the unit back on.

⚠ CAUTION: If you need to continuously reset the heater, turn the unit off at the main disconnect panel and contact technical support.

Figure 24

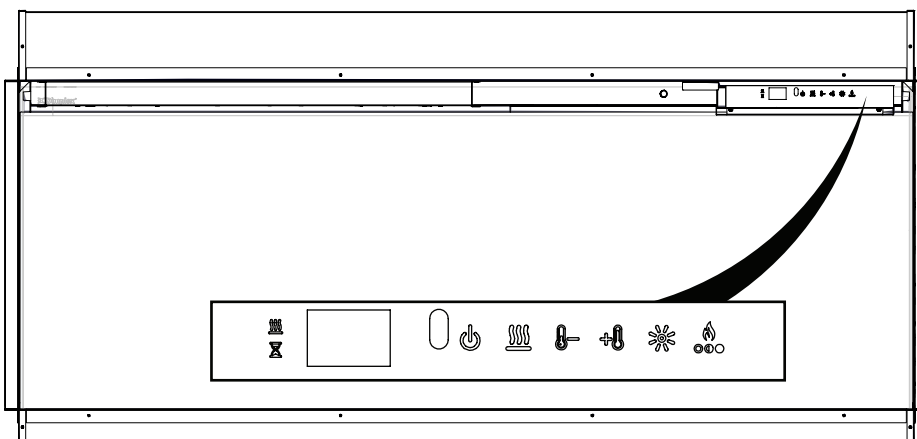
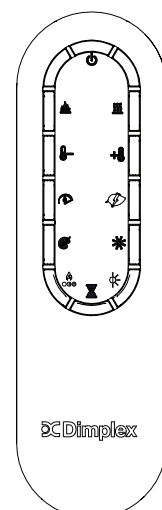









































Figure 25



Operation

	Standby	Press  to turn on the unit or to put it in standby mode. When the unit is turned back on, it will retain the previously used settings.
	Flame Effect	Press  to turn the flame effect, media, and overhead lights on or off.
	Heat	Press  to turn the heat on or off. The fireplace will beep once and the  icon will remain on the display when activated. The fireplace can be operated in heat only mode by turning off the flame and color effects.
	Heat Disable	Press and hold  and  at the same time for three seconds to disable or enable the heat function. This action must be performed on the hidden touch controls . When the heat is disabled and either the  ,  , or  is pressed, --- will appear on the display.
	Temperature Increase	Press  to increase the temperature setting.
	Temperature Decrease	Press  to decrease the temperature setting.
	Temperature Display (°C ↔ °F)	The temperature can be set from 7° C to 30° C (45° F to 86° F). When the temperature setting is adjusted, the set temperature will flash for 2 seconds, then the ambient room temperature will be displayed briefly.
	Temperature Display (°C ↔ °F)	Press and hold  and  at the same time for three seconds. This action must be performed on the hidden touch controls .
	Flame Speed	Press  repeatedly to cycle through the five different flame speeds.
	Heat Mode	Press  repeatedly to cycle through the four different heater modes: Normal: The element will automatically adjust itself to achieve and maintain the set temperature. Heat Boost: The element will work at maximum power for 20 minutes, then revert to normal heater mode. Eco: The element will work at reduced power to save energy. Fan: The element will turn off and only the fan will run.
	Moods	Press  repeatedly to cycle through the eight different Moods, which are different combinations of overhead and media bed lighting. 1 - White 2 - Blue 3 - Violet 4 - Red 5 - Green 6 - Prism — media and overhead lights cycle through colors 7 - Kaleidoscope— media and overhead lights cycle through colors at different rates 8 - Midnight mode — media and overhead lights are off Press and hold  to turn the overhead lights on or off.
	Custom Color	Freeze the media and overhead lights to a custom color. When in Prism or Kaleidoscope modes (see Moods), press  while the desired color is displayed to freeze the cycle on that color. Press  again to resume the color cycle.

Operation

	Brightness	Press  repeatedly to cycle through the brightness and flicker modes. Solid <i>H</i> - High Brightness Solid <i>L</i> - Low Brightness Cycle <i>H</i> - High Brightness with flickering media and overhead lights Cycle <i>L</i> - Low Brightness with flickering media and overhead lights
	Flame Theme	Press  repeatedly to cycle through the seven different flame themes: 1 - Base with orange and blue accents 2 - Base with orange accents 3 - Base with blue accents 4 - Blue 5 - Orange 6 - Base 7 - Orange and blue
	Ambient Light Sensor	Press  to turn the ambient light sensor on or off. The ambient light sensor will automatically adjust the brightness of the fireplace lights based on the ambient light in the room.
	Timer	Press  repeatedly until the desired number of hours of the timer is displayed. When this function is active, the fireplace will turn off after a set amount of time. The timer can be set from 30 minutes (display will show .5) to 8 hours in intervals of 30 minutes. To turn the timer off, press  repeatedly until  appears on the display. While the timer is active, press the timer button to see the time remaining.
	Factory Reset	Press and hold  and  at the same time for three seconds to reset all the settings to factory default. This action will also disconnect the unit from the Wi-Fi network if connected. This action must be performed on the hidden touch controls .

NEW! Flame Connect App



Download the **Flame Connect app** on your mobile device and create an account. With the app you can add an extra level of personalization, such as saving customized mood settings.

- Connect your electric fireplaces
- Add as many fireplaces as you like to the Flame Connect App.
- Personalize your product
- Change modes and settings on your fireplace to suit your mood.
- Secure your device
- Take ownership of a product to prevent unauthorized access.

For additional information, visit www.dimplex.com/fcapp



Maintenance

Remote Control Battery Replacement

To replace the battery:

1. Remove battery cover of the remote control using a Philips screwdriver.
2. Correctly install one 3 Volt (CR2032 [longer life] or CR2025) battery in the battery holder with the + side facing up.
3. Secure the battery cover using the previously removed screw.



Battery must be recycled or disposed of properly. Check with your Local Authority or Retailer for recycling advice in your area.

Figure 26

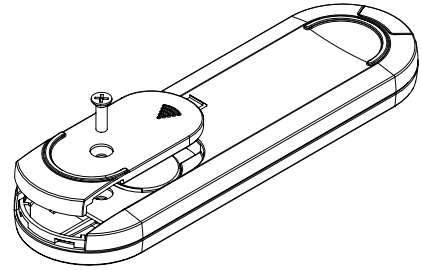

⚠ WARNING: Disconnect power and allow heater to cool before attempting any maintenance or cleaning to reduce the risk of fire, electric shock or injury to persons.

Partially Reflective Glass Cleaning

The partially reflective glass is cleaned in the factory during the assembly operation. During shipment, installation, handling, etc., the partially reflective glass may collect dust particles; these can be removed by dusting lightly with a clean dry cloth.

To remove fingerprints or other marks, the partially reflective glass can be cleaned with a damp cloth. The partially reflective glass should be completely dried with a lint-free cloth to prevent water spots. To prevent scratching, do not use abrasive cleaners.

Fireplace Surface Cleaning

Use only a damp cloth to clean painted surfaces of the fireplace. Do not use abrasive cleaners.



The fireplace should not be operated with an accumulation of dust or dirt on or in the unit, as this can cause a build-up of heat and eventual damage. For this reason the heater must be inspected regularly, depending upon conditions and at a minimum yearly intervals.

Servicing

Except for installation and cleaning described in this manual, an authorized service representative should perform any other servicing.

Troubleshooting

For more troubleshooting, consult the Service Manual.

Problem	Display	Cause	Solution
Fireplace does not turn on with the manual touch controls	N/A	No incoming power	Ensure unit is receiving power Check main disconnect panel Ensure wall switch is on (if applicable)
Fireplace does not turn on with the remote control	N/A	The batteries in the remote control are dead or installed incorrectly	Replace remote control battery Ensure battery is installed with + facing up.
Heater does not turn on	---	Heater is disabled	Press and hold  and  at the same time on the hidden touch controls for 3 seconds to disable or enable the heat function.
	H--	Heater has been permanently disabled	If installation with heat is desired, reinstall jumper on main board if available or purchase new main board.
Heater is on, but there is no heat		Normal operation — There is a 30-second delay before heater starts	No action required.
Circuit breaker trips or fuse blows when unit is turned on	N/A	Improper circuit current rating	Plug unit into a dedicated minimum 13 amp circuit.
Error Code is displayed	Err 1	Temperature cut-out is activated	Unplug power cord and wait 5 minutes before turning the unit back on. If error persists, see Service Manual.
	Err 12	Ambient temperature is above 45° C (113° F)	No action required.
	Err 13	Ambient temperature is below 5° C (41° F)	No action required.
	Err 1b	NTC not detected	See service manual.
	Err 23	Relay board not detected	See service manual.

RECYCLING



At the end of the electrical products useful life it should not be disposed of with household waste. Please recycle where facilities exist. Check with your Local Authority or retailer for recycling advice in your area.

© Glen Dimplex Flame Europe. All rights reserved. Material contained in this publication may not be reproduced in whole or in part, without prior permission in writing of Glen Dimplex Flame Europe.